

DAIKIN



INSTALLATION AND OPERATION MANUAL

VRV System air conditioners

FXFQ20AVEB
FXFQ25AVEB
FXFQ32AVEB
FXFQ40AVEB
FXFQ50AVEB
FXFQ63AVEB
FXFQ80AVEB
FXFQ100AVEB
FXFQ125AVEB

CE - DECLARATION-OF-COMFORMITY
 CE - KONFORMITÄTSEKHLARUNG
 CE - DECLARATION-DE-COMFORMITE
 CE - CONFORMITEITSEVERKLARING

CE - DECLARACION-DE-CONFORMIDAD
 CE - DICHIARAZIONE-DI-CONFORMITA
 CE - ΔΗΛΩΣΗ ΣΥΜΜΟΡΦΩΣΗΣ

CE - DECLARAÇÃO-DE-CONFORMIDADE
 CE - ЗАРЯВЛЕНИЕ-О-СОТВЕТСТВИИ
 CE - ОПВІДЛЕСЕРКЛЕРІНГ
 CE - FÖRSÄKRAN-OM-ÖVERENSÄMMEELSE

CE - IZJAVA-O-USKLABEVOSTI
 CE - ІМГОТУС-УНДЕНІМІКАІСУДЕСТА
 CE - DEKLARACJA-ZGODNOSCI
 CE - DECLARATJE-DE-CONFORMITATE

CE - IZJAVA-O SKLADNOSTI
 CE - VASTAVUSDEKLARATSIOON
 CE - ДЕКЛАРАЦІЯ-ЗА-СЪОТВѢТСТВІЕ
 CE - UYGUNLUK-BEYANI

CE - ATTIKITES-DEKLARACIA
 CE - ATBILSTIBAS-DEKLARACIA
 CE - VYHLASENIE-ZHODY
 CE - UYGUNLUK-BEYANI

Daikin Industries Czech Republic s.r.o.

- 01 (GB) declares under its sole responsibility that the air conditioning models in which this declaration relates:
- 02 (D) erklärt auf seine alleinige Verantwortung das die Modelle der Klimaanlage für die diese Erklärung bestimmt ist:
- 03 (E) déclare sous sa seule responsabilité que les appareils d'air conditionné visés par la présente déclaration:
- 04 (NL) verklaart hierbij op eigen exclusieve verantwoordelijkheid dat de airconditioning units waarop deze verklaring betrekking heeft:
- 05 (E) declara bajo su única responsabilidad que los modelos de aire acondicionado a los cuales hace referencia la declaración:
- 06 (C) dichiara sotto sua responsabilità che i condizionatori modello a cui è riferita questa dichiarazione:
- 07 (GR) δηλώνει με αποκλειστική της ευθύνη ότι τα μοντέλα των κλιματιστικών συσκευών στα οποία αναφέρεται η παρούσα δήλωση:
- 08 (P) declara sob sua exclusiva responsabilidade que os modelos de ar condicionado a que esta declaração se refere:

FXFQ20AVEB, FXFQ25AVEB, FXFQ32AVEB, FXFQ40AVEB, FXFQ50AVEB, FXFQ63AVEB,
 FXFQ80AVEB, FXFQ100AVEB, FXFQ125AVEB,

- 01 are in conformity with the following standard(s) or other normative document(s), provided that these are used in accordance with our instructions:
- 02 (E) den folgenden Norm(en) oder einem anderen Normdokument oder -dokumenten entspricht/entsprechen, unter der Voraussetzung, daß sie gemäß unserer Anweisungen eingesetzt werden:
- 03 sont conformes à (àux normes) ou autre(s) document(s) normatif(s), pour autant qu'ils soient utilisés conformément à nos instructions:
- 04 conform de volgende norm(en) of één of meer andere bindende documenten zijn, op voorwaarde dat ze worden gebruikt overeenkomstig onze instructies:
- 05 están en conformidad con la(s) siguiente(s) norma(s) u otro(s) documento(s) normativo(s), siempre que sean utilizados de acuerdo con nuestras instrucciones:
- 06 sono conformi a(l)lo(i) seguente(i) standard(i) o altro(i) documento(i) a carattere normativo, a patto che vengano usati in conformità alle nostre istruzioni:
- 07 είναι σύμφωνα με τον ακόλουθο(ι) πρότυπο(ι) ή άλλο(α) σύμμορφο(α) κειμενικό(α), υπό την προϋπόθεση ότι χρησιμοποιούνται σύμφωνα με τις οδηγίες μας:
- 08 (D) unter Einhaltung der Bestimmungsnormen:
- 09 (E) enigi vikoren:
- 10 (D) gemäß den Vorschriften der:
- 11 (E) conformément aux stipulations des:
- 12 (D) in omvanging van de bepalingen van:
- 13 (E) siglendo las disposiciones de:
- 14 (D) nach den Vorschriften der:
- 15 (E) prema odredbama:
- 16 (D) i kovi teži:
- 17 (E) zgodnie z postanowieniami Dyrekty:
- 18 (D) in Übereinstimmung mit den Bestimmungen:
- 19 ob upoštevjanju dobic:
- 20 (D) veslavljeni nulele:
- 21 (E) gemäß den Vorschriften der:
- 22 (D) in omvanging van de bepalingen van:
- 23 (E) siglendo las disposiciones de:
- 24 (D) nach den Vorschriften der:
- 25 (E) bunun koşullarına uygun olarak:

EN60335-2-40,

- 01 (D) following the provisions of:
- 02 (E) gemäß den Vorschriften der:
- 03 (D) conformément aux stipulations des:
- 04 (E) siglendo las disposiciones de:
- 05 (D) nach den Vorschriften der:
- 06 (E) prema odredbama:
- 07 (D) i kovi teži:
- 08 (E) zgodnie z postanowieniami Dyrekty:
- 09 (D) in Übereinstimmung mit den Bestimmungen:
- 10 (D) unter Einhaltung der Bestimmungsnormen:
- 11 (E) enigi vikoren:
- 12 (D) gemäß den Vorschriften der:
- 13 (E) conformément aux stipulations des:
- 14 (D) in omvanging van de bepalingen van:
- 15 (E) siglendo las disposiciones de:
- 16 (D) i kovi teži:
- 17 (E) zgodnie z postanowieniami Dyrekty:
- 18 (D) in Übereinstimmung mit den Bestimmungen:
- 19 ob upoštevjanju dobic:
- 20 (D) veslavljeni nulele:
- 21 (E) gemäß den Vorschriften der:
- 22 (D) in omvanging van de bepalingen van:
- 23 (E) siglendo las disposiciones de:
- 24 (D) nach den Vorschriften der:
- 25 (E) bunun koşullarına uygun olarak:

- 01 "D/CZ" is authorised to compile the Technical Construction File.
- 02 "D/CZ" hat die Berechtigung die Technische Konstruktionsakte zusammenzustellen.
- 03 "D/CZ" es autorisé à compiler le Dossier de Construction Technique.
- 04 "D/CZ" is bevoegd om het Technisch Constructiedossier samen te stellen.
- 05 "D/CZ" está autorizada a compilar el Archivo de Construcción Técnica.
- 06 "D/CZ" è autorizzata a redigere il File Tecnico di Costruzione.

***D/CZ=Daikin Industries Czech Republic s.r.o.

- 09 (GB) zavetuje, isključitelno pod svojo odgovornost, da model klimatisnega sistema, ki kateri se nanaša, uporablja naslednje standarde:
- 10 (D) erklärt unter meiner Verantwortung, daß die Modelle der Klimaanlage, auf die diese Erklärung bezieht, folgende Normen einhalten:
- 11 (S) deklarerar i egenansvar, att luftkonditioneringsmodellerna som berörs av denna deklaras innehålla följande standarder:
- 12 (N) erklærer at fuldstændigt ansvar for de luftkonditioneringsmodeller som berøres af denne erklæring inehæver at:
- 13 (NL) verklaart hierbij op eigen exclusieve verantwoordelijkheid dat de airconditioning units waarop deze verklaring betrekking heeft:
- 14 (CZ) prohlašuje ve své plné odpovědnosti, že modely klimatizace, k nimž se toto prohlášení vztahuje:
- 15 (HR) izjavljuje pod isključivo vlastitom odgovornošću da su modeli klima uređaja na koje se ova izjava odnosi:
- 16 (H) teljes felelősségem tudatában kijelentem, hogy a klímaberendezés modellek, melyekre a nyilatkozati vonatkozik:

- 17 (PL) deklaruje na własną wyłączną odpowiedzialność, że modele klimatyzatorów, których dotyczy niniejsza deklaracja:
- 18 (E) declara pe proprie răspundere că aparatele de aer condiționat la care se referă această declarație:
- 19 (S) de vso odgovornostjo izjavljam, da so modeli klimatiskih naprav, na katere se izjava nanaša:
- 20 (E) kimilab oma älelikul vastutusele et käesoleva deklaratsiooni alle kuuluvad klimateadmisel mudelid:
- 21 (E) deklariрам на оден отговорност, че моделите климатична системами, за които се отнася тази декларация:
- 22 (T) viisike seivo atsakomybe slesiba, kad oro kondicionavimo prietaisų modeliai, kuriems yra taikoma ši deklaracija:
- 23 (U) ar plnu atbildību apliecinu, ka šādi uzskaitīto modeļu gaisa kondicionēšanai, uz kuriem attiecas šī deklarācija:
- 24 (SK) vyhlasuje na vlastnu zodpovednost, ze tieto klimatizacne modely, na ktoré sa vzťahuje toto vyhlasenie:
- 25 (TR) lanamenim kendii sorumlulugunda otlamak (zere bi bildirimin igli oldu)u klima modelleminin asagidaki gibi oldugunu beyan eder:

- 08 estão em conformidade com a(s) seguinte(s) norma(s) ou outro(s) documento(s) normativo(s), desde que estes sejam utilizados de acordo com as nossas instruções:
- 09 соответствуют следующим стандартам или другим нормативным документам, при условии их использования согласно нашим инструкциям:
- 10 overholder standard(en) eller andet/andre retningsreguleringe dokument(er), forudsat at disse anvendes i henhold til vore instruktser:
- 11 respektive utrustning är utförd i överensstämmelse med och följer följande standard(er) eller andra normgivande dokument, under förutsättning att användning sker i överensstämmelse med våra instruktioner:
- 12 respektive uštryr er i overensstemmelse med følgende standard(er) eller andre normgivende dokument(er), under forudsætning at disse bruges i henhold til vore instruktser:
- 13 nastavak sauraten standardien ja muiden ohjeistien dokumenttien vaatimuksia edellytetien, etä niitä käytetään ohjeidemme mukaisesti:
- 14 za preopklad, že jsou využívány v souladu s našimi pokyny, odpovídají následujícím normám nebo normativním dokumentům:
- 15 u skladu sa sljedecim standardom(ima) ili drugim normativnim dokumentom(ima), za uvjet da se oni koriste u skladu s našim uputama:

**Machinery 2006/42/EC **
 Electromagnetic Compatibility 2004/108/EC ****

- 11 Information * enigi <D> oči gorkants av <E> enigi Certificat <C>:
- 12 Merk * som det fremkommer i <D> og gjennoms positiv bedømmelse av <E> tilleggs-Serifikat <C>:
- 13 Huom * pitka on esitetty asatijassa <E> ja jotta on hyväksytty Serifikatissa <E> mukaisesti.
- 14 Poznámka * jak bylo uvedeno v <E> a pozitivně zjišeno <E> v souladu s osvědčením <C>:
- 15 Napomena * kako je izloženo u <E> pozitivno ocijanjeno od strane <E> prema Serifikatu <C>:
- 16 Megjegyzés * a(z) <E> alapján, a(z) <E> igazolta a megjelölt, al(z) <C> tanúsítvány szerint.
- 17 Uwaga * zgodnie z dokumentacją <E>, pozytywną opinię <E> świadectwem <C>:
- 18 Nota * ega cum esse stabilis in <E> si apreati pozitiv de <E> in conformitate cu Certificatul <C>:
- 19 Opomba * kol je dolozeno v <E> n odobreno s strani <E> v skladu s certifikatom <C>:
- 20 Märkus * nagu on räägitud dokumentis <E> ja heaks kiidetud <E> järgi vastavalt sertifikaadile <C>:

- 19 Direktiiv, med senere ændringer.
- 20 Direktiv, med foretagne ændringer.
- 21 Директив, с внесенными изменениями.
- 22 Direktivej, salagsina kun ne oavt muuttelut.
- 23 Direktives sejin be emendat.
- 24 Direktiwa, kako je zmiinjeno.
- 25 Degriftirnis hallerleye Yfnermelkier.
- 10 Direktiiv, med senere ændringer.
- 11 Direktiv, med foretagne ændringer.
- 12 Директив, с внесенными изменениями.
- 13 Direktivej, salagsina kun ne oavt muuttelut.
- 14 v plnámim znění.
- 15 Smernica, kako je zmiinjeno.
- 16 irányelvények és módosítások rendelkezései.
- 17 z późniejszych poprawkami.
- 18 Direktiivtor, cu amendamentele respective.
- 19 "D/CZ" is authorised to compile the Technical Construction File.
- 20 "D/CZ" hat die Berechtigung die Technische Konstruktionsakte zusammenzustellen.
- 21 "D/CZ" es autorisé à compiler le Dossier de Construction Technique.
- 22 "D/CZ" is bevoegd om het Technisch Constructiedossier samen te stellen.
- 23 "D/CZ" está autorizada a compilar el Archivo de Construcción Técnica.
- 24 "D/CZ" è autorizzata a redigere il File Tecnico di Costruzione.

<A>	DAIKIN.TCF.024E16/05-2012
	TÜV (NB1856)
<C>	0510260101



Takayuki Fujii
 Managing Director
 1st of Jun, 2012

Takayuki Fujii

DAIKIN INDUSTRIES CZECH REPUBLIC s.r.o.

U Nové Hospody 1/1155, 301 00 Plzeň Skvrňany,
 Czech Republic

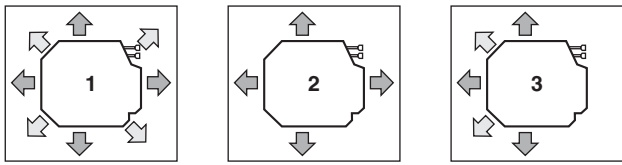

1

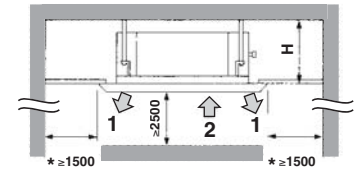

2

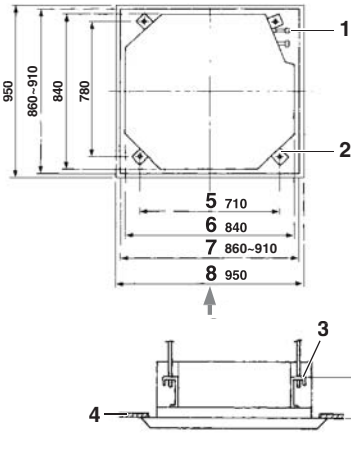

3

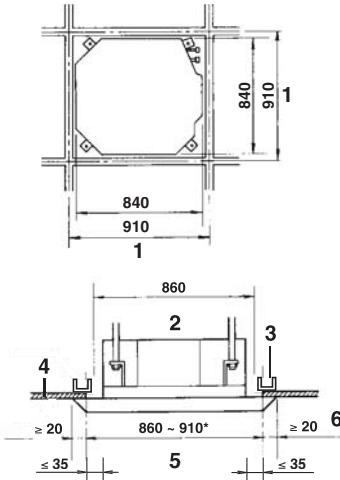

4

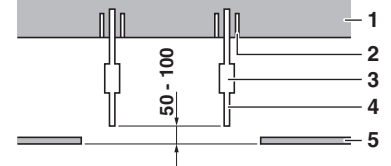

5

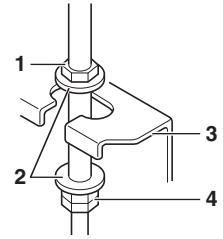

6

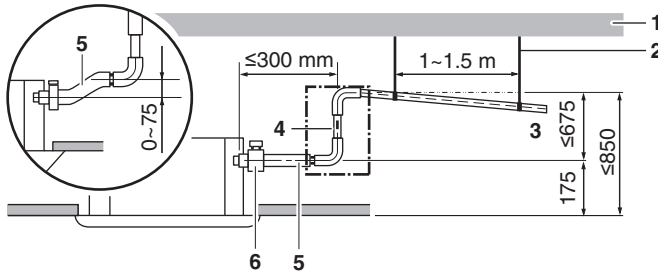

7

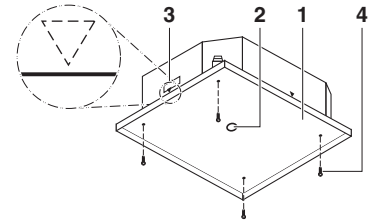

8

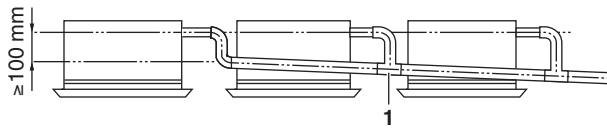

9

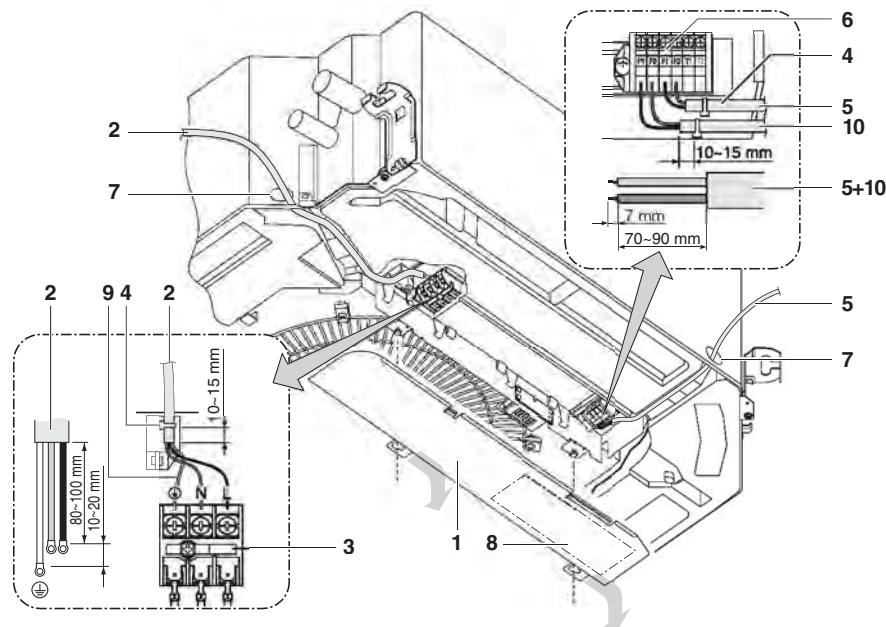
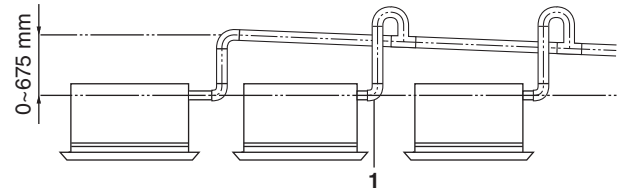

10

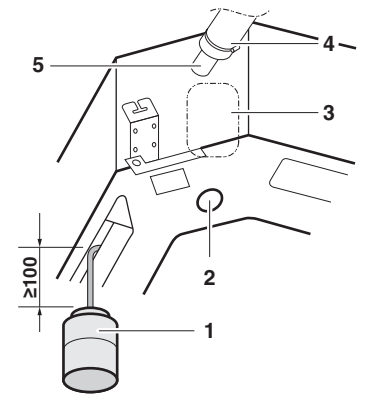

11

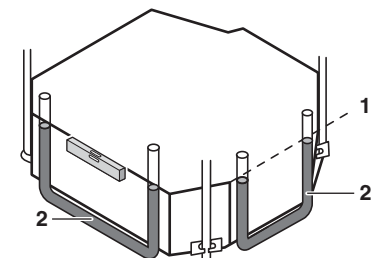

12

Contents

	Page
Before installation	1
Selecting installation site.....	2
Preparations before installation	3
Indoor unit installation	4
Refrigerant piping work	4
Drain piping work	5
Electric wiring work	7
Wiring example and how to set the remote controller.....	7
Wiring example	8
Installation of the decoration panel	8
Field setting.....	8
Test operation	9
Maintenance	9
Disposal requirements	10
Unified wiring diagram legend.....	11



READ THESE INSTRUCTIONS CAREFULLY BEFORE INSTALLATION. KEEP THIS MANUAL IN A HANDY PLACE FOR FUTURE REFERENCE.

IMPROPER INSTALLATION OR ATTACHMENT OF EQUIPMENT OR ACCESSORIES COULD RESULT IN ELECTRIC SHOCK, SHORT-CIRCUIT, LEAKS, FIRE OR OTHER DAMAGE TO THE EQUIPMENT. BE SURE ONLY TO USE ACCESSORIES, OPTIONAL EQUIPMENT AND SPARE PARTS MADE BY DAIKIN WHICH ARE SPECIFICALLY DESIGNED FOR USE WITH THE EQUIPMENT AND HAVE THEM INSTALLED BY A PROFESSIONAL.

IF UNSURE OF INSTALLATION PROCEDURES OR USE, ALWAYS CONTACT YOUR DAIKIN DEALER FOR ADVICE AND INFORMATION.

The English text is the original instruction. Other languages are translations of the original instructions.

Before installation

- Leave the unit inside its packaging until you reach the installation site. Where unpacking is unavoidable, use a sling of soft material or protective plates together with a rope when lifting, this to avoid damage or scratches to the unit.
- Refer to the installation manual of the outdoor unit for items not described in this manual.
- Caution concerning refrigerant series R410A:
The connectable outdoor units must be designed exclusively for R410A.
- Do not place objects in direct proximity of the outdoor unit and do not let leaves and other debris accumulate around the unit.
Leaves are a hotbed for small animals which can enter the unit. Once in the unit, such animals can cause malfunctions, smoke or fire when making contact with electrical parts.
- This appliance is intended to be used by expert or trained users in shops, in light industry and on farms, or for commercial use by lay persons.

Precautions

- This appliance can be used by children aged from 8 years and above and persons with reduced physical, sensory or mental capabilities or lack of experience and knowledge if they have been given supervision or instruction concerning use of the appliance in a safe way and understand the hazards involved.
- Children shall not play with the appliance.
- Cleaning and user maintenance shall not be made by children without supervision.
- If the supply cord is damaged, it must be replaced by the manufacturer, a service agent or similarly qualified persons in order to avoid a hazard.
- Do not install or operate the unit in rooms mentioned below.
 - Places with mineral oil, or filled with oil vapour or spray like in kitchens. (Plastic parts may deteriorate.)
 - Where corrosive gas like sulphurous gas exists. (Copper tubing and brazed spots may corrode.)
 - Where volatile flammable gas like thinner or gasoline is used.
 - Where machines generating electromagnetic waves exist. (Control system may malfunction.)
 - Where the air contains high levels of salt such as air near the ocean and where voltage fluctuates a lot (e.g. in factories). Also in vehicles or vessels.
- When selecting the installation site, use the supplied paper pattern for installation.
- Do not install accessories on the casing directly. Drilling holes in the casing may damage electrical wires and consequently cause fire.
- Sound pressure level is less than 70 dB(A).

Notes to the installer

- Read this manual carefully to ensure correct installation. Be sure to instruct the customer how to properly operate the system and show him/her the enclosed operation manual.

Explain to the customer what system is installed on the site. Be sure to fill out the appropriate installation specifications in the chapter "What to do before operation" of the outdoor unit operation manual.

Accessories

Check if the following accessories are included with your unit.

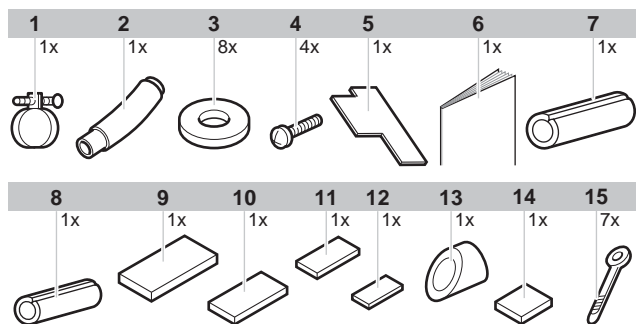

- 1 Metal clamp
- 2 Drain hose
- 3 Washer for hanger bracket
- 4 Screw
- 5 Installation guide
- 6 Installation and operation manual
- 7 Insulation for fitting for gas pipe
- 8 Insulation for fitting for liquid pipe
- 9 Large sealing pad
- 10 Medium 1 sealing pad
- 11 Medium 2 sealing pad
- 12 Small sealing pad
- 13 Drain sealing pad
- 14 Paper pattern for installation (upper part of packing)
- 15 Clamp

Optional accessories

- There are two types of remote controllers: wired and wireless. Select a remote controller according to customers request and install in an appropriate place. Refer to catalogues and technical literature for selecting a suitable remote controller.
- This indoor unit requires installation of an optional decoration panel.

Information requirements for fan coil units			
Item	Symbol	Value	Unit
Cooling capacity (sensible)	$P_{rated, c}$	A	kW
Cooling capacity (latent)	$P_{rated, c}$	B	kW
Heating capacity	$P_{rated, h}$	C	kW
Total electric power input	P_{elec}	D	kW
Sound power level (per speed setting if applicable)	L_{WA}	E	dB
Contact details	DAIKIN INDUSTRIES CZECH REPUBLIC s.r.o. U Nové Hospody 1/1155, 301 00 Plzeň Skvrňany, Czech Republic		

THE ABOVE TABLE RELATES TO THE MODELS AND VALUES STATED IN THIS TABLE

Models	A	B	C	D	E
FXFQ20AVEB	1.8	0.4	2.5	0.038	49
FXFQ25AVEB	2.1	0.7	3.2	0.038	49
FXFQ32AVEB	2.8	0.8	4	0.038	49
FXFQ40AVEB	3.4	1.1	5	0.038	51
FXFQ50AVEB	4.1	1.5	6.3	0.053	51
FXFQ63AVEB	5.2	1.9	8	0.061	53
FXFQ80AVEB	6.5	2.5	10	0.092	55
FXFQ100AVEB	7.8	3.4	12.5	0.115	60
FXFQ125AVEB	9.8	4.2	16	0.186	61

For the following items, take special care during construction and check after installation is finished

Tick ✓ when checked	
<input type="checkbox"/>	Is the indoor unit fixed firmly? The unit may drop, vibrate or make noise.
<input type="checkbox"/>	Is the gas leak test finished? It may result in insufficient cooling or heating.
<input type="checkbox"/>	Is the unit fully insulated? Condensate water may drip.
<input type="checkbox"/>	Does drainage flow smoothly? Condensate water may drip.
<input type="checkbox"/>	Does the power supply voltage correspond to that shown on the name plate? The unit may malfunction or components may burn out.
<input type="checkbox"/>	Are wiring and piping correct? The unit may malfunction or components may burn out.
<input type="checkbox"/>	Is the unit safely grounded? Dangerous at electric leakage.
<input type="checkbox"/>	Is the wiring size according to specifications? The unit may malfunction or components may burn out.
<input type="checkbox"/>	Is nothing blocking the air outlet or inlet of either the indoor or outdoor units? It may result in insufficient cooling or heating.
<input type="checkbox"/>	Are refrigerant piping length and additional refrigerant charge noted down? The refrigerant charge in the system might not be clear.

Important information regarding the refrigerant used

This product contains fluorinated greenhouse gases. Do not vent gases into the atmosphere.

Refrigerant type: **R410A**

GWP ⁽¹⁾ value: **2087.5**

⁽¹⁾ GWP = global warming potential

Periodical inspections for refrigerant leaks may be required depending on European or local legislation. Please contact your local dealer for more information.



NOTICE regarding tCO₂eq

In Europe, the **greenhouse gas emissions** of the total refrigerant charge in the system (expressed as tonnes CO₂-equivalent) is used to determine the maintenance intervals. Follow the applicable legislation.

Formula to calculate the greenhouse gas emissions:

GWP value of the refrigerant × Total refrigerant charge [in kg] / 1000

Selecting installation site

When the conditions in the ceiling are exceeding 30°C and a relative humidity of 80%, or when fresh air is inducted into the ceiling, an additional insulation is required (minimum 10 mm thickness, polyethylene foam).

For this unit you can select different air flow directions. It is necessary to purchase an optional blocking pad kit to discharge the air in 3 or 4 (closed corners) directions.

Install the unit so that air vents, lights, or machines near the unit do not interfere with the air flow.

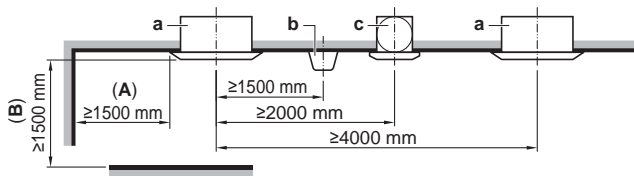

- a Indoor unit
- b Lighting
The figure describes about a ceiling lighting, but a recessed ceiling light is not restricted.
- c Air fan
- A If the air outlet is closed, space marked (A) should be 500 mm at least. In addition, if both the right and left corner of this air outlet are closed, space marked (A) should be 200 mm at least.
- B ≥1500 mm from any static volume

1 Select an installation site where the following conditions are fulfilled and that meets your customer's approval.

- Where optimum air distribution can be ensured.
- Where nothing blocks air passage.
- Where condensate water can be properly drained.
- Where the false ceiling is not noticeably on an incline.
- Where sufficient clearance for maintenance and service can be ensured.
- Where there is no risk of flammable gas leaking.
- The equipment is not intended for use in a potentially explosive atmosphere.
- Where piping between indoor and outdoor units is possible within the allowable limit. (Refer to the installation manual of the outdoor unit.)
- This is a class A product. In a domestic environment this product may cause radio interference in which case the user may be required to take adequate measures.
- Keep indoor unit, outdoor unit, inter unit wiring and remote controller at least 1 meter away from televisions and radios. This is to prevent image interference and noise in those electrical appliances. (Noise may be generated depending on the conditions under which the electric wave is generated, even if 1 meter is kept.)
- When installing the wireless remote controller kit, the distance between wireless remote controller and indoor unit might be shorter if there are fluorescent lights who are electrically started in the room. The indoor unit must be installed as far as possible away from fluorescent lights.

2 Ceiling height

This indoor unit may be installed on ceilings up to 3.5 m in height (for 125 units: 4.2 m). However, it becomes necessary to make field settings by the remote controller when installing the unit at a height over 2.7 m (for 125 units: 3.2 m). Install the unit higher than 2.5 m to avoid accidental touching. Refer to "Field setting" on page 8 and to the decoration panel installation manual.

3 Air flow directions

Select the air flow directions best suited to the room and point of installation. (For air discharge in 3 directions, it is necessary to make field settings by means of the remote controller and to close the air outlet(s). Refer to the installation manual of the optional blocking pad kit and to "Field setting" on page 8.) (See figure 1 (⇨ = air flow direction))

- 1 All round air discharge
- 2 Air discharge in 4 directions
- 3 Air discharge in 3 directions

NOTE Air flow directions as shown in figure 1 merely serve as examples of possible air flow directions.

4 Use suspension bolts for installation. Check whether the ceiling is strong enough to support the weight of the indoor unit. If there is a risk, reinforce the ceiling before installing the unit.

(The installation pitch is marked on the paper pattern for installation. Refer to it to check for points requiring reinforcing.)

Space required for installation see figure 2 (⇨ = air flow direction)

- 1 Air discharge
- 2 Air inlet

NOTE Leave 200 mm or more space where marked with *; on sides where the air outlet is closed.

Model	H
FXFQ20~63	≥214
FXFQ80+100	≥256
FXFQ125	≥298

Preparations before installation

1. Relation of ceiling opening to unit and suspension bolt position.

(See figure 3)

- 1 Refrigerant piping
- 2 Suspension bolt (x4)
- 3 Hanger bracket
- 4 False ceiling
- 5 Suspension bolt pitch
- 6 Indoor unit
- 7 Ceiling opening
- 8 Decoration panel

■ Use the installation guide (delivered with the unit) for exact vertical positioning of the unit.

Apply the short side of the installation guide in case of **normal installation**

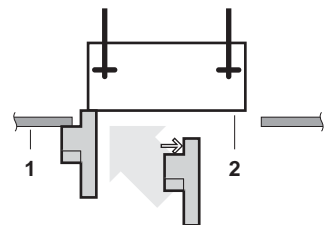

Apply the long side of the installation guide in case of **installation with fresh air intake kit**

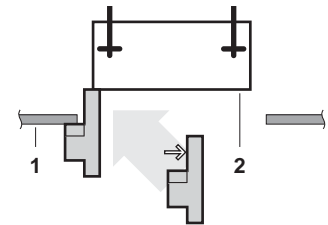

Apply the long side of the installation guide after removal of the tear-off tab in case of **installation with self cleaning decoration panel**

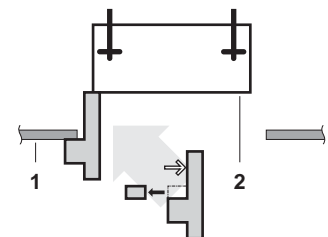

- 1 Lower ceiling surface
- 2 Underside of the unit

- Installation is possible when opening dimensions are as follows.

When installing the unit within the frame for fixing ceiling materials. (See figure 4)

- 1 Dimensions inside frame
- 2 Opening dimension inside the frame for ceiling
- 3 Frame
- 4 Ceiling material
- 5 Ceiling opening dimension
- 6 Ceiling-panel overlapping dimension

NOTE



Installation is possible with a ceiling dimension of 910 mm (marked with *). However, to achieve a ceiling-panel overlapping dimension of 20 mm, the spacing between the ceiling and the unit should be 35 mm or less. If the spacing between ceiling and the unit is over 35 mm, attach ceiling material to the part or recover the ceiling.

2. Make the ceiling opening needed for installation where applicable. (For existing ceilings.)

- Refer to the paper pattern for installation for the ceiling opening dimensions.
- Create the ceiling opening required for installation. From the side of the opening to the casing outlet, implement the refrigerant and drain piping and wiring for remote controller (unnecessary for wireless type) and indoor-outdoor unit casing outlet. Refer to each piping or wiring section.
- After making an opening in the ceiling, it may be necessary to reinforce ceiling beams to keep the ceiling level and to prevent it from vibrating. Consult the builder for details.

3. Install the suspension bolts. (use either a W3/8 or M10 size bolt.)

Use anchors for existing ceilings, and a sunken insert, sunken anchors or other field supplied parts for new ceilings to reinforce the ceiling in order to bear the weight of the unit. Adjust clearance from the ceiling before proceeding further.

Installation example see figure 5.

- 1 Ceiling slab
- 2 Anchor
- 3 Long nut or turn-buckle
- 4 Suspension bolt
- 5 False ceiling

NOTE



All the above parts are field supplied.

For other installation than standard installation, contact your dealer for details.

Indoor unit installation

When installing optional accessories (except for the decoration panel), read also the installation manual of the optional accessories. Depending on the field conditions, it may be easier to install optional accessories before the indoor unit is installed. However, for existing ceilings, install fresh air intake kit before installing the unit.

Installation shall be done by an installer, the choice of materials and installation shall comply with the applicable legislation. In Europe the EN378 is the applicable standard that shall be used.

1. Install the indoor unit temporarily.

- Attach the hanger bracket to the suspension bolt. Be sure to fix it securely by using a nut and washer from the upper and lower sides of the hanger bracket.
- Securing the hanger bracket see figure 6.

- 1 Nut (field supplied)
- 2 Washer (supplied with the unit)
- 3 Hanger bracket
- 4 Double nut (field supply, tighten)

2. Fix the paper pattern for installation. (For new ceilings only.)

- The paper pattern for installation corresponds with the measurements of the ceiling opening. Consult the builder for details.
- The centre of the ceiling opening is indicated on the paper pattern for installation. The centre of the unit is indicated on the unit casing and on the paper pattern for installation.
- After removing the packaging material from the paper pattern for installation, attach the paper pattern for installation to the unit with the attached screws as shown in figure 8.

- 1 Paper pattern for installation
- 2 Centre of the ceiling opening
- 3 Centre of the unit
- 4 Screws (supplied with the unit)

- Adjust the height of the unit until it matches the indication in figure 8.

3. Adjust the unit to the right position for installation.

(Refer to "Preparations before installation" on page 3.)

4. Check if the unit is horizontally levelled.

- Do not install the unit tilted. The indoor unit is equipped with a built-in drain pump and float switch. (If the unit is tilted against the direction of the condensate flow (the drain piping side is raised), the float switch may malfunction and cause water to drip.)
- Check if the unit is levelled at all four corners with a water level or a water-filled vinyl tube as shown in figure 12.

- 1 Water level
- 2 Vinyl tube

5. Remove the paper pattern for installation. (For new ceilings only.)

Refrigerant piping work

For refrigerant piping of outdoor unit, refer to the installation manual supplied with the outdoor unit.

Execute heat insulation work completely on both sides of the gas piping and the liquid piping. Otherwise, this can sometimes result in water leakage.

Before rigging tubes, check which type of refrigerant is used.

Protect or enclose refrigerant tubing to avoid mechanical damage.



All field piping must be provided by a licensed refrigeration technician and must comply with the relevant local and national codes.

- Use a pipe cutter and flare suitable for the used refrigerant.
- To prevent dust, moisture or other foreign matter from infiltrating the tube, either pinch the end, or cover it with tape.
- Use copper alloy seamless pipes (ISO 1337).
- The outdoor unit is charged with refrigerant.
- To prevent water leakage, execute heat insulation work completely on both sides of the gas and liquid piping. When using a heat pump, the temperature of the gas piping can reach up to approximately 120°C, use insulation which is sufficiently heat resistant.

- Be sure to use both a spanner and torque wrench together when connecting or disconnecting pipes to/from the unit.

- Torque wrench
- Spanner
- Piping union
- Flare nut

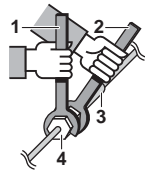

- Do not mix anything other than the specified refrigerant, such as air, etc..., inside the refrigerant circuit.
- Refer to Table 1 for the dimensions of flare nut spaces and the appropriate tightening torque. (Overtightening may damage the flare and cause leaks.)

Table 1

Pipe gauge	Tightening torque	Flare dimension A (mm)	Flare shape
Ø6.4	15~17 N•m	8.7~9.1	
Ø9.5	33~39 N•m	12.8~13.2	
Ø12.7	50~60 N•m	16.2~16.6	
Ø15.9	63~75 N•m	19.3~19.7	

- When connecting the flare nut, coat the flare inner surface with ether oil or ester oil and initially tighten 3 or 4 turns by hand before tightening firmly.

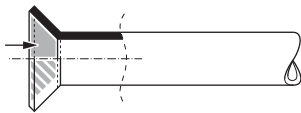

- If the refrigerant gas leaks during the work, ventilate the area. A toxic gas is emitted by the refrigerant gas being exposed to a fire.
- Make sure there is no refrigerant gas leak. A toxic gas may be released by the refrigerant gas leaking indoor and being exposed to flames from an area heater, cooking stove, etc.
- Finally, insulate as shown in the figure below (use the supplied accessory parts)

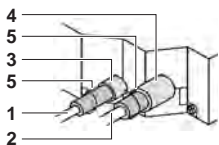

- Liquid pipe
- Gas pipe
- Insulation for fitting for liquid pipe
- Insulation for fitting for gas pipe
- Clamps (use 2 clamps per insulation)

Piping insulation procedure

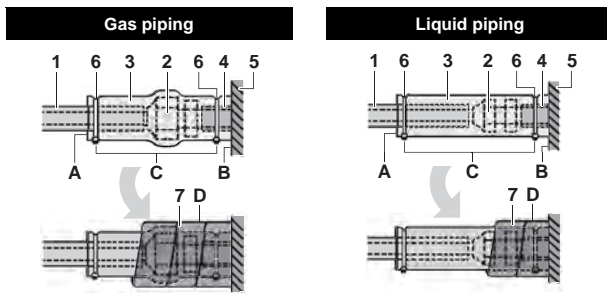

- Piping insulation material (field supply)
- Flare nut connection
- Insulation for fitting (delivered with the unit)
- Piping insulation material (main unit)
- Main unit
- Clamp (field supply)
- Medium 1 sealing pad for gas piping (delivered with the unit)
Medium 2 sealing pad for liquid piping (delivered with the unit)

Gas piping

- Turn seams up
- Attach to base
- Tighten the part other than the piping insulation material
- Wrap over from the base of the unit to the top of the flare nut connection

Liquid piping



- For local insulation, be sure to insulate local piping all the way into the pipe connections inside the unit.
Exposed piping may cause condensation or may cause burns when touched.
- Make sure that no oil remains on plastic parts of the decoration panel (optional equipment).
Oil may cause degradation and damage to the plastic parts.

Cautions for brazing

- Be sure to carry out a nitrogen blow when brazing. Brazing without carrying out nitrogen replacement or releasing nitrogen into the piping will create large quantities of oxidized film on the inside of the pipes, adversely affecting valves and compressors in the refrigerating system and preventing normal operation.
- When brazing while inserting nitrogen into the piping, nitrogen must be set to 0.02 MPa with a pressure-reducing valve (=just enough so that it can be felt on the skin).

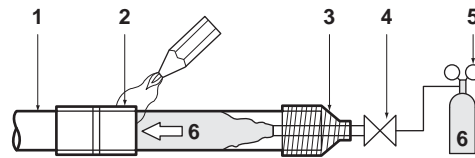

- Refrigerant piping
- Part to be brazed
- Taping
- Hands valve
- Pressure-reducing valve
- Nitrogen

Drain piping work

Installation of drain piping

Install the drain piping as shown in figure and take measures against condensation. Improperly rigged piping could lead to leaks and eventually wet furniture and belongings.

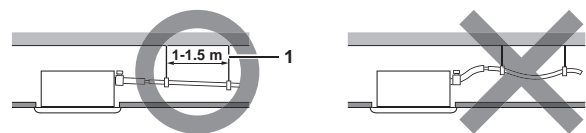

- Hanging bar

- Install the drain pipes.
 - Keep piping as short as possible and slope it downwards at a gradient of at least 1/100 so that air may not remain trapped inside the pipe.
 - Keep pipe size equal to or greater than that of the connecting pipe (vinyl pipe of 25 mm nominal diameter and 32 mm outer diameter).
 - Push the supplied drain hose as far as possible over the drain socket.

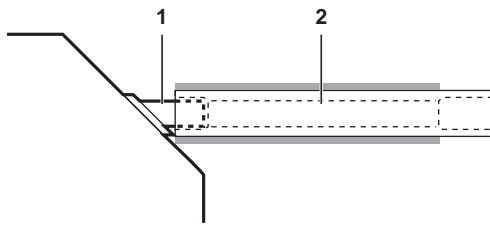

- 1 Drain socket (attached to the unit)
- 2 Drain hose (supplied with the unit)

- Tighten the metal clamp until the screw head is less than 4 mm from the metal clamp part as indicated in the illustration.
- After the testing of drain piping is finished, attach the drain sealing pad (4) supplied with the unit over the uncovered part of the drain socket (= between drain hose and unit body).

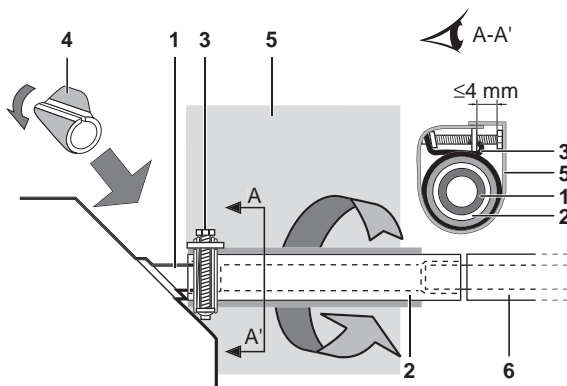

- 1 Drain socket (attached to the unit)
- 2 Drain hose (supplied with the unit)
- 3 Metal clamp (supplied with the unit)
- 4 Drain sealing pad (supplied with the unit)
- 5 Large sealing pad (supplied with the unit)
- 6 Drain piping (field supply)

- Wrap the supplied large sealing pad over the metal clamp and drain hose to insulate and fix it with clamps.
- Insulate the complete drain piping inside the building (field supply).
- If the drain hose cannot be sufficiently set on a slope, fit the hose with drain raising piping (field supply).

■ How to perform piping (See figure 7)

- 1 Ceiling slab
- 2 Hanger bracket
- 3 Adjustable range
- 4 Drain raising pipe (nominal diameter of vinyl pipe = 25 mm)
- 5 Drain hose (supplied with the unit)
- 6 Clamp metal (supplied with the unit)

- 1 Connect the drain hose to the drain raising pipes, and insulate them.
- 2 Connect the drain hose to the drain outlet on the indoor unit, and tighten it with the clamp.

■ Precautions

- Install the drain raising pipes at a height of less than 675 mm.
- Install the drain raising pipes at a right angle to the indoor unit and no more than 300 mm from the unit.
- To prevent air bubbles, install the drain hose level or slightly tilted up (≤75 mm).

NOTE



The incline of attached drain hose should be 75 mm or less so that the drain socket does not have to withstand additional force.

To ensure a downward slope of 1:100, install hanging bars every 1 to 1.5 m.

When unifying multiple drain pipes, install the pipes as shown in figure 9. Select converging drain pipes whose gauge is suitable for the operating capacity of the unit.

- 1 T-joint converging drain pipes

Testing of drain piping

After piping work is finished, check if drainage flows smoothly.

- Add approximately 1 l of water gradually through the air discharge outlet.

Method of adding water. See figure 11.

- 1 Plastic watering can (tube should be about 100 mm long)
- 2 Service drain outlet (with rubber plug) (Use this outlet to drain water from the drain pan)
- 3 Drain pump location
- 4 Drain pipe
- 5 Drain socket (water flow view point)

- Check the drainage flow.

- In case electric wiring work is finished

Check drainage flow during COOL running, explained in "Test operation" on page 9.

- In case electric wiring work is not finished

- Remove the control box lid. Connect the power supply firmly to the terminal. See figure 10.
- Reattach the control box lid and turn on the power.
- Do not touch the drain pump. It may result in electric shock.

- 1 Control box lid
- 2 Power supply wiring
- 3 Power supply terminal block
- 4 Clamp (field supply)
- 5 Unit transmission wiring
- 6 Terminal block for transmission wiring
- 7 Opening for cables
- 8 Wiring diagram label (on the back side of the control box lid)
- 9 Earth cable
- 10 Remote controller wiring

Power supply terminal block (3)

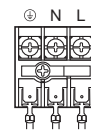

- Confirm the drain operation looking at the drain socket.
- After checking the drainage flow, turn off the power, remove the control box lid and disconnect the power supply from the terminal again.
- Reattach the control box lid.

Electric wiring work

General instructions

- All field supplied parts and materials and electric works must conform to local codes.
- Use copper wire only.
- Follow the "Wiring diagram" attached to the unit body to wire the outdoor unit, indoor units and the remote controller. For details on hooking up the remote controller, refer to the "Installation manual of the remote controller".
- All wiring must be performed by an authorized electrician.
- Attach the earth leakage circuit breaker and fuse to the power supply line.
- A main switch or other means for disconnection, having a contact separation in all poles, must be incorporated in the fixed wiring in accordance with relevant local and national legislation.
Note that the operation will restart automatically if the main power supply is turned off and then turned back on again.
- This system consists of multiple indoor units. Mark each indoor unit as unit A, unit B..., and be sure the terminal block wiring to the outdoor unit and BS unit are properly matched. If wiring and piping between the outdoor unit and an indoor unit are mismatched, the system may cause a malfunction.
- Be sure to ground the air conditioner.
- Do not connect the ground wire to:
 - gas pipes: might cause explosions or fire if gas leaks.
 - telephone ground wires or lightning rods: might cause abnormally high electric potential in the ground during lightning storms.
 - plumbing pipes: no grounding effect if hard vinyl piping is used.

Electrical characteristics

Model	Hz	Volts	Voltage range
FXFQ20~125	50 / 60	220-240 / 220	min. 198-max. 264 / min. 198-max. 242

Model	power supply		Fan motor	
	MCA	MFA	KW	FLA
FXFQ20~32	0.4	16 A	0.056	0.3
FXFQ40	0.5	16 A	0.056	0.4
FXFQ50	0.6	16 A	0.056	0.5
FXFQ63	0.9	16 A	0.056	0.7
FXFQ80	0.9	16 A	0.120	0.7
FXFQ100	1.4	16 A	0.120	1.1
FXFQ125	1.9	16 A	0.120	1.5

MCA: Min. circuit Amps (A)
 MFA: Max. Fuse Amps (A)
 KW: Fan Motor Rated Output (kW)
 FLA: Full Load Amps (A)

NOTE For details, refer to "Electrical data".



Specifications for field supplied fuses and wire

Model	Power supply wiring		
	Field fuses	Wire	Size
FXFQ20~125	16 A	H05VV-U3G	Local codes

Model	Transmission wiring	
	Wire	Size
FXFQ20~125	Sheathed wire (2)	0.75-1.25 mm ²

NOTE



- For details, refer to "Wiring example" on page 8.
- Allowable length of transmission wiring between indoor and outdoor units, and between the indoor unit and the remote controller is as follows:
 - Outdoor unit - indoor unit: max. 1000 m (total wiring length: 2000 m)
 - Indoor unit - remote controller: max 500 m

Wiring example and how to set the remote controller

How to connect wiring (See figure 10)

- Power supply wiring
Remove the control box lid (1) and connect the wires to the power supply terminal block inside (L, N) and connect the ground wire to the grounding terminal. While doing this, pull the wires inside through the hole in the casing and clamp the wires along with other wires using a clamp as indicated in the figure.
- Unit transmission wiring and remote controller wiring
Remove the control box lid (1) and pull the wires inside through the hole in the casing and connect to the terminal block for unit transmission wiring (F1, F2) and remote controller wiring (P1, P2). Securely fix the wiring using a clamp as indicated in the figure.
- After connection
Attach the small sealing (supplied with the unit) around the cables to prevent infiltrating of water from the outside into the unit. If two or more cables are used, divide the small sealing into the required number of pieces and wrap them around all the cables.
- Attach the control box lid.

Precautions

- 1 Observe the notes mentioned below when wiring to the power supply terminal block.
 - Use a round crimp-style terminal for insulation sleeve for connection to the terminal block for wiring the units. When none are available, follow the instructions below.

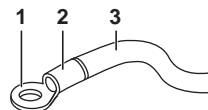

- 1 Round crimp-style terminal
- 2 Attach insulation sleeve
- 3 Wiring

- Do not connect wires of different gauge to the same power supply terminal. (Looseness in the connection may cause overheating.)
- When clamping wiring, use the clamps (delivered with the unit) to prevent outside pressure being exerted on the wiring connections. Tie up firmly. When doing the wiring, make sure the wiring is neat and does not cause the control box to stick up. Close the cover firmly.
- When connecting wires of the same gauge, connect them according to the figure.



Use the specified electric wire. Connect the wire securely to the terminal. Lock the wire down without applying excessive force to the terminal. Use torques according to the table below.

Tightening torque (N•m)	
Terminal block for unit transmission and remote controller	0.79~0.97
Terminal block for power supply	1.18~1.44

- When attaching the control box lid, make sure not to pinch any wires.
- After all wiring connections are done, fill in any gaps in the casing wiring holes with putty or insulation material (field supply) thus to prevent small animals or dirt from entering the unit from outside and causing short circuits in the control box.

- 2 Keep total current of crossover wiring between indoor units less than 12 A. Branch the line outside the terminal block of the unit in accordance with electrical equipment standards, when using two power wiring of a gauge greater than 2 mm² (Ø1.6).
The branch must be sheathed in order to provide an equal or greater degree of insulation as power supply wiring itself.
- 3 Do not connect wires of different gauge to the same grounding terminal. Looseness in the connection may deteriorate the protection.
- 4 Remote controller wiring and unit transmission wiring should be located at least 50 mm away from power supply wiring. Not following this guideline may result in malfunction due to electrical noise.
- 5 For the remote controller wiring, refer to the "Installation manual of the remote controller" supplied with the remote controller.

NOTE  The customer has the ability to select the remote controller thermistor.

- 6 Never connect the power supply wiring to the terminal block for transmission wiring. This mistake could damage the entire system.
- 7 Use only specified wires and tightly connect wires to the terminals. Be careful that wires do not place external stress on the terminals. Keep wiring in neat order so that they do not obstruct other equipment such as popping open the service cover. Make sure the cover closes tight. Incomplete connections could result in overheating, and in the worse case, electric shock or fire.

Wiring example

Fit the power supply wiring of each unit with a switch and fuse as shown in figure 17.

- 1 Power supply
- 2 Main switch
- 3 Power supply wiring
- 4 Unit transmission wiring
- 5 Switch
- 6 Fuse
- 7 BS unit (REYQ only)
- 8 Indoor unit
- 9 Remote controller

Complete system example (3 systems)

See figures 13, 14 and 15.

- 1 Outdoor unit
- 2 Indoor unit
- 3 Remote controller (Optional accessories)
- 4 Most downstream indoor unit
- 5 For use with 2 remote controllers
- 6 BS unit

When using 1 remote controller for 1 indoor unit. (Normal operation)

(See figure 13).

For group control or use with 2 remote controllers (See figure 14).

When including BS unit (See figure 15).

NOTE  It is not necessary to designate indoor unit address when using group control. The address is automatically set when the power is activated.

Precautions

1. A single switch can be used to supply power to units on the same system. However, branch switches and branch circuit breakers must be selected carefully.
2. For a group control remote controller, choose the remote controller that suits the indoor unit which has the most functions.

3. Do not ground the equipment on gas pipes, water pipes, lightning rods or crossground with telephones. Improper grounding could result in electric shock.

Installation of the decoration panel

Refer to the installation manual delivered with the decoration panel.

After installing the decoration panel, ensure that there is no space between the unit body and decoration panel. Otherwise air may leak through the gap and cause dewdrop.

Field setting

Field setting must be made from the remote controller in accordance with the installation condition.

- Setting can be made by changing the "Mode number", "First code No." and "Second code No."
- For setting and operation, refer to the "Field setting" in the installation manual of the remote controller.

Summary of field settings

Mode No. (Note 1)	First code No.	Description of setting	Second code No. (Note 2)			
			01	02	03	04
10 (20)	0	Filter contamination - Heavy/Light = Setting to define time between 2 filter cleaning display indications. (When contamination is high, setting can be changed to half the time in between 2 filter cleaning display indications.) Long-life filter	Light ±2,500 hrs.	Heavy ±1,250 hrs.	—	—
	2	Thermostat sensor selection	Use both the unit sensor (or remote sensor if installed) AND the remote controller sensor. (See note 5+6)	Use unit sensor only (or remote sensor if installed). (See note 5+6)	Use remote controller sensor only. (See note 5+6)	—
	3	Setting for display of time between 2 filter cleaning display indications	Display	Do not display	—	—
	5	Information to I-manager, I-touch controller	Only unit sensor value (or remote sensor value if installed).	Sensor value as set by 10-2-0X or 10-6-0X.	—	—
	6	Thermostat sensor in group control	Use unit sensor only (or remote sensor if installed). (See note 6)	Use both the unit sensor (or remote sensor if installed) AND the remote controller sensor. (See note 4+5+6)	—	—
12 (22)	0	Output signal X1-X2 of the optional KRP1B PCB kit	Thermostat-on+compressor run	—	Operation	Mal-function
	1	ON/OFF input from outside (T1/T2 input) = Setting when forced ON/OFF is to be operated from outside.	Forced OFF	ON/OFF operation	—	—
	2	Thermostat differential changeover = Setting when remote sensor is used.	1°C	0.5°C	—	—
	3	Fan setting during thermostat OFF at heating operation	LL	Set speed	OFF (See note 3)	—
	4	Differential automatic changeover	0°C	1°C	2°C	3°C (See note 7)
5	Auto-restart after power failure	Disabled	Enabled	—	—	

Mode No. (Note 1)	First code No.	Description of setting	Second code No. (Note 2)			
			01	02	03	04
13 (23)	0	Setting for air outlet velocity This setting is to be changed in function of ceiling height.	other models ≤2.7 m	>2.7 ≤3.0 m	>3.0 ≤3.5 m	—
		FXFQ125 only	≤3.2 m	>3.2 ≤3.6 m	>3.6 ≤4.2 m	—
	1	Selection for air flow direction This setting is to be changed when blocking pad optional kit is used.	4-way flow	3-way flow	—	—
	4	Airflow direction range setting This setting is to be changed when range of swing flap movement needs to be changed.	Upper	Medium	Lower	—

- Note 1:** Setting is carried out in the group mode, however, if the mode number inside parentheses is selected, indoor units can also be set individually.
- Note 2:** Factory settings of the Second code No. are marked in grey backgrounds.
- Note 3:** Only use in combination with optional remote sensor or when setting 10-2-03 is used.
- Note 4:** If group control is selected and remote sensor is to be used, then set 10-6-02 & 10-2-03.
- Note 5:** If setting 10-6-02 + 10-2-01 or 10-2-02 or 10-2-03 are set at the same time, then setting 10-2-01, 10-2-02 or 10-2-03 have priority.
- Note 6:** If setting 10-6-01 + 10-2-01 or 10-2-02 or 10-2-03 are set at the same time, then setting for group connection, 10-6-01 has priority and for individual connection, 10-2-01, 10-2-02 or 10-2-03 have priority.
- Note 7:** More settings for Differential automatic change over temperatures are:
 Second code No. 05 4°C
 06 5°C
 07 6°C
 08 7°C

- When using wireless remote controllers it is necessary to use address setting. Refer to the installation manual attached to the wireless remote controller for the setting instructions.

Control by 2 Remote Controllers (Controlling 1 indoor unit by 2 remote controllers)

When using 2 remote controllers, one must be set to "MAIN" and the other to "SUB".

Main/sub changeover

- Insert a wedge-head screwdriver into the recess between the upper and lower part of the remote controller and, working from the 2 positions, pry off the upper part. (See figure 19) (The remote controller PC board is attached to the upper part of the remote controller.)
- Turn the main/sub changeover switch on one of the two remote controller PC boards to "S". (See figure 20) (Leave the switch of the other remote controller set to "M".)
 - Remote controller PC board
 - Factory setting
 - Only one remote controller needs to be changed

Computerised control (forced off and on/off operation)

- Wire specifications and how to perform wiring.
 - Connect input from outside to terminals T1 and T2 of the terminal block (remote controller to transmission wiring).

Wire specification	Sheathed vinyl cord or cable (2 wire)
Gauge	0.75-1.25 mm ²
Length	Max. 100 m
External terminal	Contact that can ensure the minimum applicable load of 15 V DC, 1 mA

See figure 18.

- Input A
- Actuation
 - The following table explains "forced off" and "on/off operations" in response to input A.

Forced off	on/off operation
Input "on" stops operation	input off → on: turns on the unit (impossible by remote controllers)

Forced off	on/off operation
Input "off" enables control	input on → off: turns off the unit (by remote controller)

- How to select forced off and on/off operation
 - Turn the power on and then use the remote controller to select operation.
 - Set the remote controller to the field set mode. For details, refer to the chapter "How to set in the field", in the remote controller manual.
 - When in the field set mode, select mode No. 12, then set the first code (switch) No. to "1". Then set second code (position) No. to "01" for forced off and to "02" for on/off operation. (forced off at factory set.) (See figure 16)

- Second code No.
- Mode No.
- First code No.
- Field set mode

Centralized control

For centralized control, it is necessary to designate the group No. For details, refer to the manual of each optional controller for centralized control.

Test operation

Refer to the installation manual of the outdoor unit.

- NOTE** When performing field settings or test operation without attaching the decoration panel, do not touch the drain pump. This may cause electric shock.

The operation lamp of the remote controller will flash when an error occurs. Check the error code on the liquid crystal display to identify the trouble. Refer to the installation manual attached to the outdoor unit or contact your dealer. See figure 22.

- Drain pumping device (built-in) drain water is removed from the room during cooling
- Air flow flap (at air outlet)
- Air outlet
- Remote controller
- Suction grille
- Air filter (inside suction grille)

Maintenance

CAUTION

- Only a qualified service person is allowed to perform maintenance.
- Before obtaining access to terminal devices, all power supply circuits must be interrupted.
- To clean the air conditioner, be sure to stop operation and turn the power switch off. Otherwise, an electric shock and injury may result.
- Do not wash the air conditioner with water. Doing so may result in an electric shock.
- Be careful with scaffoldings. Caution must be exercised when working in high places.
- After a long use, check the unit stand and fitting for damage. If damaged, the unit may fall and cause injury.
- Do not touch the heat exchanger fins. The fins are sharp and could result in cutting injuries.
- When cleaning the heat exchanger, be sure to remove the control box, fan motor, drain pump and float switch. Water or detergent may deteriorate the insulation of electronic components and result in burn-out of these components.

How to clean the air filter

Clean the air filter when the display shows "  " (TIME TO CLEAN AIR FILTER).

Increase the frequency of cleaning if the unit is installed in a room where the air is extremely contaminated.

(As a yardstick for yourself, consider cleaning the filter once a half year.)

If dirt becomes impossible to clean, change the air filter. (Air filter for exchange is optional.)

NOTE  Do not wash the air filter with hot water of more than 50°C. Doing so may result in discoloration and/or deformation.

Do not expose the unit to fire. Doing so may result in burning.

- 1 Open the suction grille (See [figure 21](#)) (action 1 in the illustration).
Push both levers simultaneously in the direction of the arrow as indicated in the illustration and carefully lower the grille. (Identical procedure for closing.)
- 2 Remove the air filter (actions 2 to 4 in the illustration).
Pull the air filter clip on both the bottom left and the right side of the filter toward you, and detach the filter.
- 3 Clean the air filter. (See [figure 23](#))
Use vacuum cleaner or wash the air filter with water.
When the air filter is very dirty, use soft brush and neutral detergent.
- 4 Remove water and dry in the shade.
- 5 Install the air filter back in place (perform actions 2 to 4 in the illustration in reverse order).
Attach the air filter to the suction grille by hanging it over the projected portion above the suction grille.
Press the bottom of the air filter against the projections on the bottom of the grille to snap the air filter into its place.
- 6 Close the suction grille by performing procedure step 1 in reverse order.
- 7 After turning on the power, press the FILTER SIGN RESET button.
The "TIME TO CLEAN AIR FILTER" display vanishes.

NOTE  Do not remove the air filter except when cleaning. Unnecessary handling may damage the filter.

How to clean the suction grille

(See [figure 21](#))

- 1 Open the suction grille (action 1 in the illustration).
Refer to procedure step 1 in "[How to clean the air filter](#)" on [page 10](#).
- 2 Detach the suction grille (actions 5 to 6 in the illustration).
First detach the 2 strings from the pins of the decoration panel.
Hold the suction grille open at 45 degrees and lift it upward to unhook it from the decoration panel.
- 3 Remove the air filter (actions 2 to 4 in the illustration).
Refer to procedure step 2 in "[How to clean the air filter](#)" on [page 10](#).
- 4 Clean the suction grille.
Wash with a soft bristle brush and neutral detergent or water, and dry thoroughly. See [figure 24](#).

NOTE  When the suction grille is very dirty, use a typical kitchen cleaner and let it sit for about 10 minutes. Then, wash it with water.

Do not wash the suction grille with hot water of more than 50°C. Doing so may result in discoloration and/or deformation.

- 5 Install the air filter back in place (perform actions 2 to 4 in the illustration in reverse order).
- 6 Reattach the suction grille by performing procedure step 2 in reverse order (perform actions 5 to 6 in the illustration in reverse order).
- 7 Close the suction grille by performing procedure step 1 in reverse order.

How to clean the air outlet and outside panels

- Clean with a soft cloth.
- When it is difficult to remove stains, use water or neutral detergent.

NOTE  Do not use gasoline, benzene, thinner, polishing powder, liquid insecticide. It may cause discoloring or warping.

Do not let the indoor unit get wet. It may cause an electric shock or a fire.

Do not scrub firmly when washing the blade with water. The surface sealing may peel off.

Do not use water or air of 50°C or higher for cleaning air filters and outside panels.

Disposal requirements

















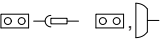

Your product and the batteries supplied with the controller are marked with this symbol. This symbol means that electrical and electronic products and batteries shall not be mixed with unsorted household waste. For batteries, a chemical symbol can be printed beneath the symbol. This chemical symbol means that the

battery contains a heavy metal above a certain concentration. Possible chemical symbols are:

- Pb: lead (>0.004%)

Do not try to dismantle the system yourself: the dismantling of the product, treatment of the refrigerant, of oil and of other parts must be done by a qualified installer in accordance with relevant local and national legislation. Units and waste batteries must be treated at a specialized treatment facility for re-use, recycling and recovery. By ensuring correct disposal, you will help to prevent potential negative consequences for the environment and human health. Please contact the installer or local authority for more information.

Unified wiring diagram legend

Unified Wiring Diagram Legend			
For applied parts and numbering refer to the wiring diagram sticker supplied on the unit. Part numbering is realized by Arabic numbers in ascending order for each part and is represented in the overview below by symbol "##" in the part code.			
	: CIRCUIT BREAKER		: PROTECTIVE EARTH
	: CONNECTION		: PROTECTIVE EARTH (SCREW)
	: CONNECTOR		: RECTIFIER
	: EARTH		: RELAY CONNECTOR
	: FIELD WIRING		: SHORT CIRCUIT CONNECTOR
	: FUSE		: TERMINAL
	: INDOOR UNIT		: TERMINAL STRIP
	: OUTDOOR UNIT		: WIRE CLAMP
BLK : BLACK	GRN : GREEN	PNK : PINK	WHT : WHITE
BLU : BLUE	GRY : GREY	PRP, PPL : PURPLE	YLW : YELLOW
BRN : BROWN	ORG : ORANGE	RED : RED	
A*P : PRINTED CIRCUIT BOARD	PS : SWITCHING POWER SUPPLY		
BS* : PUSH BUTTON ON / OFF, OPERATION SWITCH	PTC* : THERMISTOR PTC		
BZ, H*O : BUZZER	Q* : INSULATED GATE BIPOLAR TRANSISTOR (IGBT)		
C* : CAPACITOR	Q*DI : EARTH LEAK CIRCUIT BREAKER		
AC*, CN*, E*, HA*, HE, HL*, HN*, HR*, MR*_A, MR*_B, S*, U, V, W, X*A, K*R_*	Q*L : OVERLOAD PROTECTOR		
D*, V*D : DIODE	Q*M : THERMO SWITCH		
DB* : DIODE BRIDGE	R* : RESISTOR		
DS* : DIP SWITCH	R*T : THERMISTOR		
E*H : HEATER	RC : RECEIVER		
F*U, FU* (FOR CHARACTERISTICS REFER TO PCB INSIDE YOUR UNIT)	S*C : LIMIT SWITCH		
FG* : CONNECTOR (FRAME GROUND)	S*L : FLOAT SWITCH		
H* : HARNESS	S*NPH : PRESSURE SENSOR (HIGH)		
H*P, LED*, V*L : PILOT LAMP, LIGHT EMITTING DIODE	S*NPL : PRESSURE SENSOR (LOW)		
HAP : LIGHT EMITTING DIODE (SERVICE MONITOR GREEN)	S*PH, HPS* : PRESSURE SWITCH (HIGH)		
HIGH VOLTAGE : HIGH VOLTAGE	S*PL : PRESSURE SWITCH (LOW)		
IES : INTELLIGENT EYE SENSOR	S*T : THERMOSTAT		
IPM* : INTELLIGENT POWER MODULE	S*W, SW* : OPERATION SWITCH		
K*R, KCR, KFR, KHuR, K*M	SA*, F1S : SURGE ARRESTOR		
L : LIVE	SR*, WLU : SIGNAL RECEIVER		
L* : COIL	SS* : SELECTOR SWITCH		
L*R : REACTOR	SHEET METAL : TERMINAL STRIP FIXED PLATE		
M* : STEPPER MOTOR	T*R : TRANSFORMER		
M*C : COMPRESSOR MOTOR	TC, TRC : TRANSMITTER		
M*F : FAN MOTOR	V*, R*V : VARISTOR		
M*P : DRAIN PUMP MOTOR	V*R : DIODE BRIDGE		
M*S : SWING MOTOR	WRC : WIRELESS REMOTE CONTROLLER		
MR*, MRCW*, MRM*, MRN*	X* : TERMINAL		
N : NEUTRAL	X*M : TERMINAL STRIP (BLOCK)		
n = *, N = *	Y*E : ELECTRONIC EXPANSION VALVE COIL		
PAM : PULSE-AMPLITUDE MODULATION	Y*R, Y*S : REVERSING SOLENOID VALVE COIL		
PCB* : PRINTED CIRCUIT BOARD	Z*C : FERRITE CORE		
PM* : POWER MODULE	ZF, Z*F : NOISE FILTER		

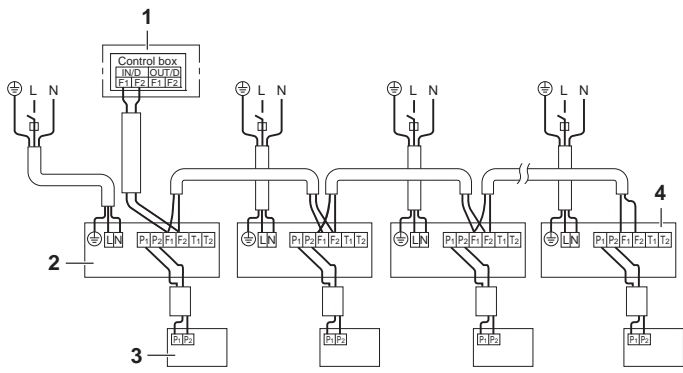

13

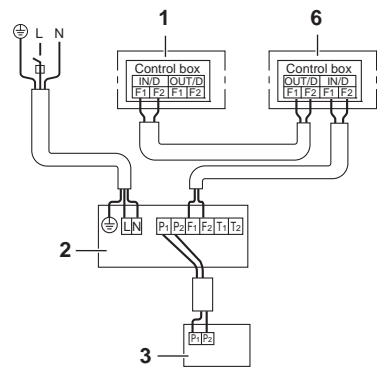

15

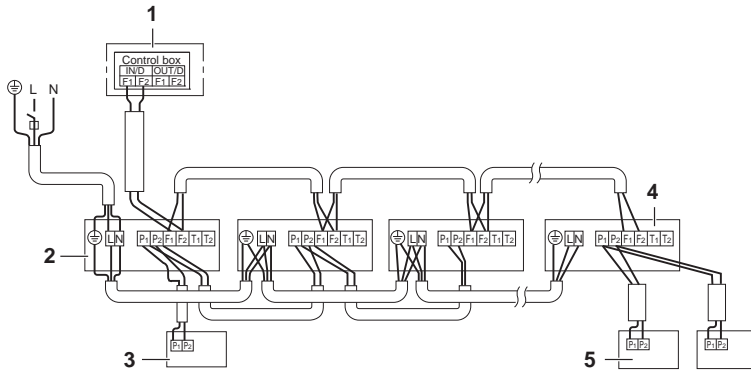

14

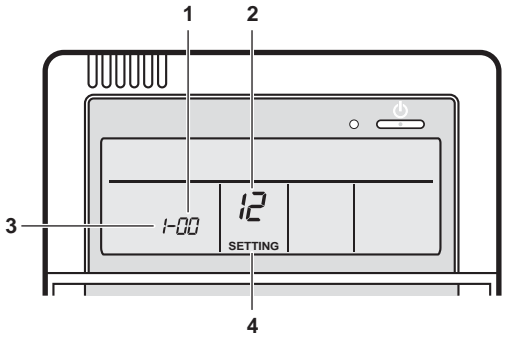

16

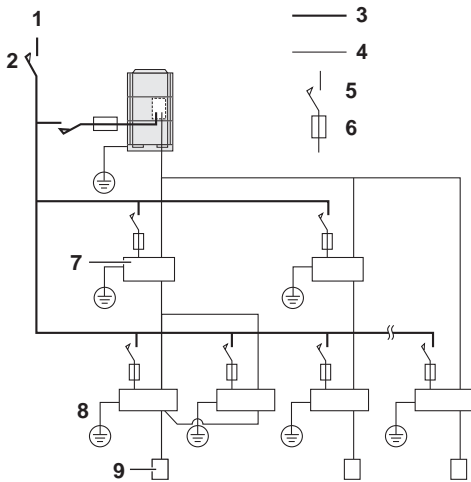

17

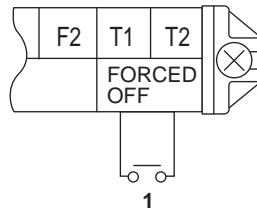

18

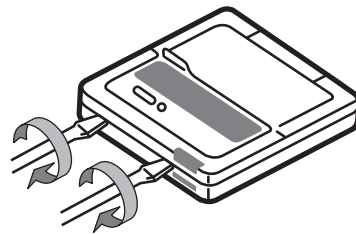

19

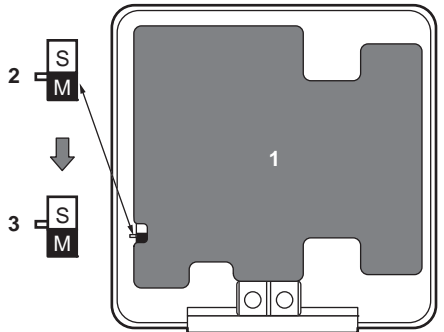

20

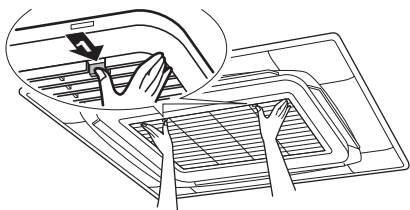

21

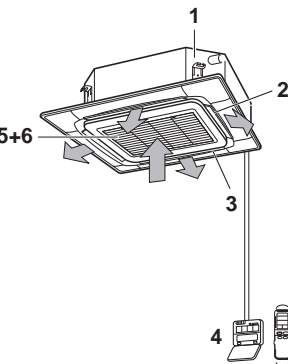
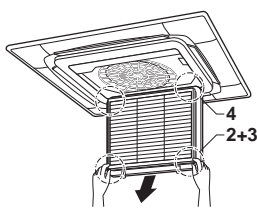

22

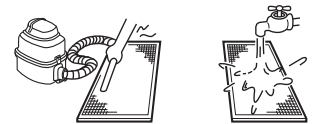

23

24

DAIKIN INDUSTRIES CZECH REPUBLIC s.r.o.

U Nové Hospody 1/1155, 301 00 Plzeň Skvrňany, Czech Republic

DAIKIN EUROPE N.V.

Zandvoordestraat 300, B-8400 Oostende, Belgium

Copyright 2012 Daikin